

# LM48511 Boomer<sup>®</sup> Audio Power Amplifier Series

## 3W, Ultra-Low EMI, Filterless, Mono, Class D Audio Power Amplifier with Spread Spectrum

### General Description

The LM48511 integrates a boost converter with a high efficiency Class D audio power amplifier to provide 3W continuous power into an 8Ω speaker when operating from a 5V power supply. When operating from a 3V to 4V power supply, the LM48511 can be configured to drive 1 to 2.5W into an 8Ω load with less than 1% distortion (THD+N). The Class D amplifier features a low noise PWM architecture that eliminates the output filter, reducing external component count, board area consumption, system cost, and simplifying design. A selectable spread spectrum modulation scheme suppresses RF emissions, further reducing the need for output filters.

The LM48511's switching regulator is a current-mode boost converter operating at a fixed frequency of 1MHz. Two selectable feedback networks allow the LM48511 regulator to dynamically switch between two different output voltages, improving efficiency by optimizing the amplifier's supply voltage based on battery voltage and output power requirements.

The LM48511 is designed for use in portable devices, such as GPS, mobile phones, and MP3 players. The high, 80% efficiency at 5V, extends battery life when compared to Boosted Class AB amplifiers. Independent regulator and amplifier shutdown controls optimize power savings by disabling the regulator when high output power is not required.

The gain of the LM48511 is set by external resistors, which allows independent gain control from multiple sources by summing the signals. Output short circuit and thermal overload protection prevent the device from damage during fault conditions. Superior click and pop suppression eliminates audible transients during power-up and shutdown.

### Key Specifications

- Quiescent Power Supply Current
 

$V_{DD} = 3V$	9mA (typ)
$V_{DD} = 5V$	13.5mA (typ)
- $P_O$  at  $V_{DD} = 5V$ ,  $PV1 = 7.8V$   
 $R_L = 8\Omega$ , THD+N = 1% 3.0W (typ)
- $P_O$  at  $V_{DD} = 3V$ ,  $PV1 = 4.8V$   
 $R_L = 8\Omega$ , THD+N = 1% 1W (typ)
- $P_O$  at  $V_{DD} = 5V$ ,  $PV1 = 7.8V$   
 $R_L = 4\Omega$ , THD+N = 1% 5.4W (typ)
- Shutdown Current at  $V_{DD} = 3V$  0.01μA (typ)

### Features

- 3W Output into 8Ω at 5V with THD+N = 1%
- Selectable spread spectrum mode reduces EMI
- 80% Efficiency
- Independent Regulator and Amplifier Shutdown Controls
- Dynamically Selectable Regulator Output Voltages
- Filterless Class D
- 3.0V – 5.5V operation
- Low Shutdown Current
- Click and Pop Suppression

### Applications

- GPS
- Portable media
- Cameras
- Mobile Phones
- Handheld games

### EMI Graph

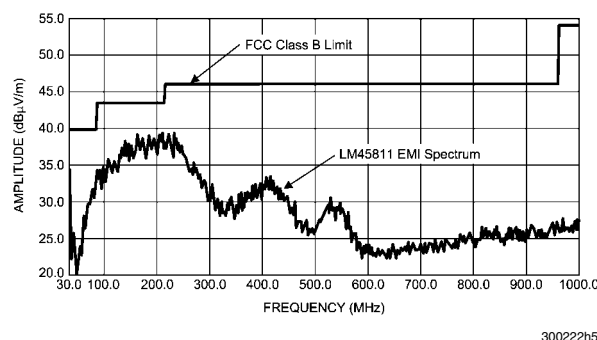

FIGURE 1. LM48511 RF Emissions — 3 inch cable

Boomer<sup>®</sup> is a registered trademark of National Semiconductor Corporation.

# Typical Application

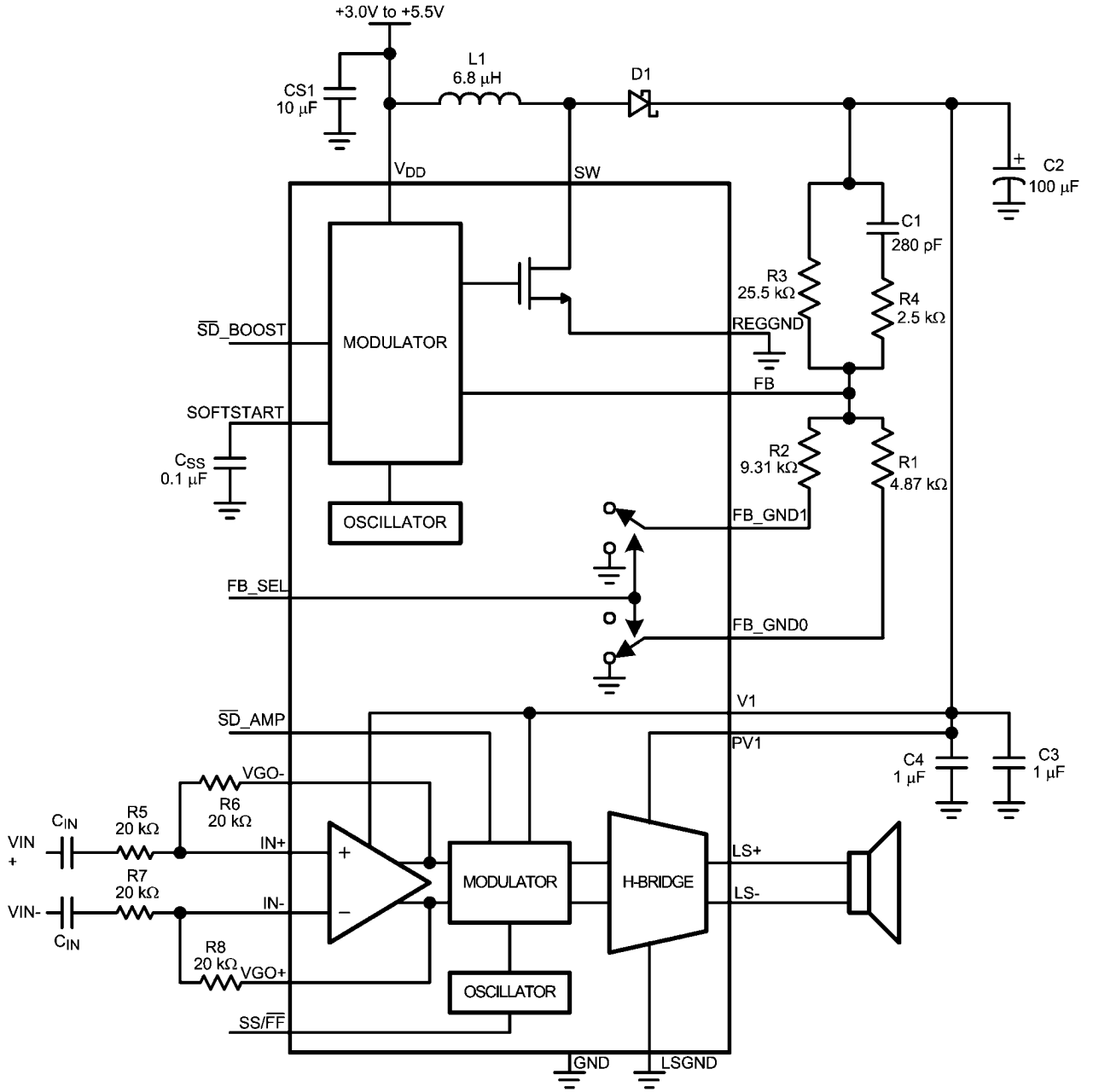
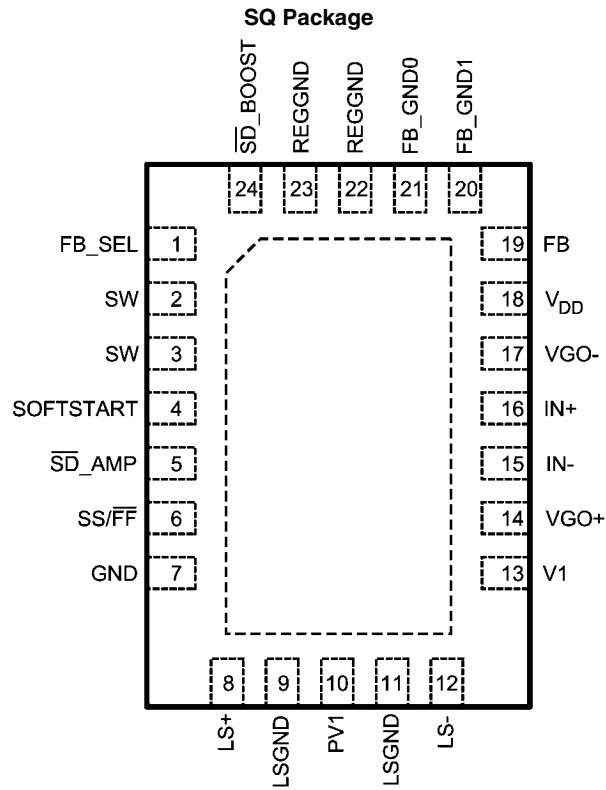

FIGURE 2. Typical LM48511 Audio Amplifier Application Circuit

300222i3

# Connection Diagrams



**Top View**  
**Order Number LM48511SQ**  
**See NS Package Number SQA24B**

**SQ Package Marking**

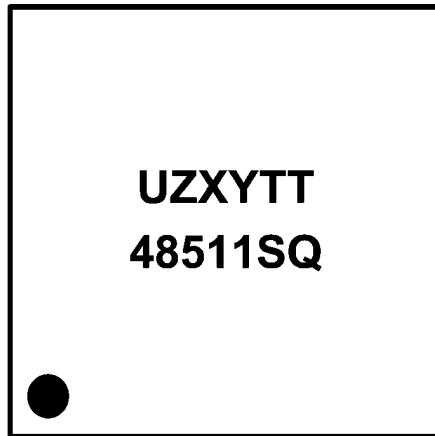

300222d5

**Top View**  
**U — Wafer fab code**  
**Z — Assembly plant**  
**XY — 2 Digit date code**  
**TT — Lot traceability**

## Pin Descriptions

LLP-24 Pin	Name	Function
1	FB_SEL	Regulator Feedback Select. Connect to VDD to select feedback network connected to FB_GND1. Connect to GND to select feedback network connected to FB_GND0.
2,3	SW	Drain of the Internal FET Switch
4	SOFTSTART	Soft Start Capacitor
5	$\overline{SD\_AMP}$	Amplifier Active Low Shutdown. Connect to V <sub>DD</sub> for normal operation. Connect to GND to disable amplifier.
6	SS/ $\overline{FF}$	Modulation Mode Select. Connect to V <sub>DD</sub> for spread spectrum mode (SS). Connect to GND for fixed frequency mode (FF).
7	GND	Signal Ground
8	LS+	Amplifier Non-Inverting Output
9, 11	LSGND	Amplifier H-Bridge Ground
10	PV1	Amplifier H-Bridge Power Supply. Connect to V1.
12	LS-	Amplifier Inverting Output
13	V1	Amplifier Supply Voltage. Connect to PV1
14	VG0+	Amplifier Non-Inverting Gain Output
15	IN-	Amplifier Inverting Input
16	IN+	Amplifier Non-Inverting Input
17	VG0-	Amplifier Inverting Gain Output
18	VDD	Power Supply
19	FB	Regulator Feedback Input. Connect FB to an external resistive voltage divider to set the boost output voltage.
20	FB_GND1	Ground return for R <sub>3</sub> , R <sub>1</sub> resistor divider
21	FB_GND0	Ground return for R <sub>3</sub> , R <sub>2</sub> resistor divider
22,23	REGGND	Power Ground (Booster)
24	$\overline{SD\_BOOST}$	Regulator Active Low Shutdown. Connect to V <sub>DD</sub> for normal operation. Connect to GND to disable regulator.
DAP		To be soldered to board for enhanced thermal dissipation. Connect to GND plane.

**Absolute Maximum Ratings** (Notes 2, 2)

If Military/Aerospace specified devices are required, please contact the National Semiconductor Sales Office/Distributors for availability and specifications.

Supply Voltage ( $V_{DD}$ , $PV_1$ , $V_1$ )	9V
Storage Temperature	-65°C to +150°C
Input Voltage	-0.3V to $V_{DD} + 0.3V$
Power Dissipation (Note 3)	Internally limited
ESD Susceptibility (Note 4)	2000V
ESD Susceptibility (Note 5)	200V
Junction Temperature	150°C

Thermal Resistance

$\theta_{JC}$ (SQ)	3.8°C/W
$\theta_{JA}$ (SQ)	32.8°C/W

**Operating Ratings**

Temperature Range	$T_{MIN} \leq T_A \leq T_{MAX}$		$-40^\circ\text{C} \leq T_A \leq +85^\circ\text{C}$
Supply Voltage ( $V_{DD}$ )			$3.0V \leq V_{DD} \leq 5.5V$
Amplifier Voltage ( $PV_1$ , $V_1$ )			$4.8V \leq PV_1 \leq 8.0V$

**Electrical Characteristics**  $V_{DD} = 5.0V$  (Notes 1, 2, 10)

The following specifications apply for  $V_{DD} = 5.0V$ ,  $PV_1 = 7.8V$  (continuous mode),  $A_V = 2V/V$ ,  $R_3 = 25.5k\Omega$ ,  $R_{LS} = 4.87k\Omega$ ,  $R_L = 8\Omega$ ,  $f = 1kHz$ ,  $SS/\overline{FF} = GND$ , unless otherwise specified. Limits apply for  $T_A = 25^\circ\text{C}$ .

Symbol	Parameter	Conditions	LM48511		Units (Limits)
			Typical (Note 6)	Limit (Note 7)	
$I_{DD}$	Quiescent Power Supply Current	$V_{IN} = 0$ , $R_{LOAD} = \infty$			
		Fixed Frequency Mode (FF)	13.5		mA (max)
		Spread Spectrum Mode (SS)	14.5	22	mA (max)
$I_{SD}$	Shutdown Current	$V_{SD\_BOOST} = V_{SD\_AMP} = SS = FB\_SEL = GND$	0.11	1	$\mu\text{A}$ (max)
$V_{IH}$	Logic Voltage Input High		1.03	1.4	V (min)
$V_{IL}$	Logic Voltage Input Low		0.92	0.4	V (min)
$T_{WU}$	Wake-up Time	$C_{SS} = 0.1\mu\text{F}$	49		ms
$V_{OS}$	Output Offset Voltage	Note 12	0.01	3	mV
$P_O$	Output Power	$R_L = 8\Omega$ $f = 1kHz$ , $BW = 22kHz$			
		THD+N = 1%			
		FF	3.0	2.6	W (min)
		SS	3.0		W
		THD+N = 10%			
		FF	3.8		W
		SS	3.8		W
		$R_L = 4\Omega$ $f = 1kHz$ , $BW = 22kHz$			
		THD+N = 1%			
		FF	5.4		W
		SS	5.4		W
		THD+N = 10%			
FF	6.7		W		
SS	6.7		W		
THD+N	Total Harmonic Distortion + Noise	$P_O = 2W$ , $f = 1kHz$ , $R_L = 8\Omega$			
		FF	0.03		%
		SS	0.03		%
		$P_O = 3W$ , $f = 1kHz$ , $R_L = 4\Omega$			
		FF	0.04		%
		SS	0.05		%

Symbol	Parameter	Conditions	LM48511		Units (Limits)
			Typical (Note 6)	Limit (Note 7)	
$\epsilon_{OS}$	Output Noise	f = 20Hz to 20kHz Inputs to AC GND, No weighting			
		FF	32		$\mu V_{RMS}$
		SS	32		$\mu V_{RMS}$
		f = 20Hz to 20kHz Inputs to AC GND, A weighted			
PSRR	Power Supply Rejection Ratio (Input Referred)	$V_{RIPPLE} = 200mV_{P-P}$ Sine, $f_{RIPPLE} = 217Hz$ , FF	88		dB
		SS	87		dB
		$V_{RIPPLE} = 200mV_{P-P}$ Sine, $f_{RIPPLE} = 1kHz$ , FF	88		dB
		SS	85		dB
		$V_{RIPPLE} = 200mV_{P-P}$ Sine, $f_{RIPPLE} = 10kHz$ , FF	77		dB
		SS	76		dB
CMRR	Common Mode Rejection Ratio (Input Referred)	$V_{RIPPLE} = 1V_{P-P}$ , $f_{RIPPLE} = 217Hz$	73		dB
$\eta$	Efficiency	f = 1kHz, $R_L = 8\Omega$ , $P_O = 1W$	80		%
$V_{FB}$	Feedback Pin Reference Voltage		1.23		V

### Electrical Characteristics $V_{DD} = 3.6V$ (Notes 1, 2, 10)

The following specifications apply for  $V_{DD} = 3.6V$ ,  $PV1 = 7V$  (continuous mode),  $A_V = 2V/V$ ,  $R_3 = 25.5k\Omega$ ,  $R_{LS} = 5.36k\Omega$ ,  $R_L = 8\Omega$ ,  $f = 1kHz$ ,  $SS/FF = GND$ , unless otherwise specified. Limits apply for  $T_A = 25^\circ C$ .

Symbol	Parameter	Conditions	LM48511		Units (Limits)
			Typical (Note 6)	Limit (Note 7)	
$I_{DD}$	Quiescent Power Supply Current	$V_{IN} = 0$ , $R_{LOAD} = \infty$			
		Fixed Frequency Mode (FF)	16		mA (max)
		Spread Spectrum Mode (SS)	17.5	26.6	mA (max)
$I_{SD}$	Shutdown Current	$V_{SD\_BOOST} = V_{SD\_AMP} = SS =$ $FB\_SEL = GND$	0.03	1	$\mu A$ (max)
$V_{IH}$	Logic Voltage Input High		0.96	1.4	V (min)
$V_{IL}$	Logic Voltage Input Low		0.84	0.4	V (min)
$T_{WU}$	Wake-up Time	$C_{SS} = 0.1\mu F$	50		ms
$V_{OS}$	Output Offset Voltage	Note 12	0.04		mV

Symbol	Parameter	Conditions	LM48511		Units (Limits)
			Typical (Note 6)	Limit (Note 7)	
$P_O$	Output Power	$R_L = 8\Omega$ , $f = 1\text{kHz}$ , $BW = 22\text{kHz}$			
		THD+N = 1%			
		FF	2.5		W
		SS	2.5		W
		THD+N = 10%			
		FF	3.0		W
		SS	3.0		W
$P_O$	Output Power	$R_L = 4\Omega$ , $f = 1\text{kHz}$ , $BW = 22\text{kHz}$			
		THD+N = 1%			
		FF	4.3		W
		SS	4.2		W
		THD+N = 10%			
		FF	5.4		W
		SS	5.3		W
THD+N	Total Harmonic Distortion + Noise	$P_O = 1.5\text{W}$ , $f = 1\text{kHz}$ , $R_L = 8\Omega$			
		FF	0.03		%
		SS	0.03		%
		$P_O = 3\text{W}$ , $f = 1\text{kHz}$ , $R_L = 4\Omega$			
$\epsilon_{OS}$	Output Noise	$f = 20\text{Hz}$ to $20\text{kHz}$ Inputs to AC GND, No weighting			
		FF	35		$\mu\text{V}_{\text{RMS}}$
		SS	36		$\mu\text{V}_{\text{RMS}}$
		$f = 20\text{Hz}$ to $20\text{kHz}$ Inputs to AC GND, A weighted			
PSRR	Power Supply Rejection Ratio (Input Referred)	$V_{\text{RIPPLE}} = 200\text{mV}_{\text{P-P}}$ Sine, $f_{\text{RIPPLE}} = 217\text{Hz}$			
		FF	85		dB
		SS	86		dB
		$V_{\text{RIPPLE}} = 200\text{mV}_{\text{P-P}}$ Sine, $f_{\text{RIPPLE}} = 1\text{kHz}$			
		FF	87		dB
		SS	86		dB
CMRR	Common Mode Rejection Ratio (Input Referred)	$V_{\text{RIPPLE}} = 1\text{V}_{\text{P-P}}$ , $f_{\text{RIPPLE}} = 217\text{Hz}$			
		FF	73		dB
$\eta$	Efficiency	$f = 1\text{kHz}$ , $R_L = 8\Omega$ , $P_O = 1\text{W}$		77	%
$V_{\text{FB}}$	Feedback Pin Reference Voltage			1.23	V

## Electrical Characteristics $V_{DD} = 3.0V$ (Notes 1, 2, 10)

The following specifications apply for  $V_{DD} = 3.0V$ ,  $PV1 = 4.8V$  (continuous mode),  $A_V = 2V/V$ ,  $R_3 = 25.5k\Omega$ ,  $R_{LS} = 9.31k\Omega$ ,  $R_L = 8\Omega$ ,  $f = 1kHz$ ,  $SS/\overline{FF} = GND$ , unless otherwise specified. Limits apply for  $T_A = 25^\circ C$ .

Symbol	Parameter	Conditions	LM48511		Units (Limits)
			Typical (Note 6)	Limit (Note 7)	
$I_{DD}$	Quiescent Power Supply Current	$V_{IN} = 0, R_{LOAD} = \infty$			
		Fixed Frequency Mode (FF)	9		mA (max)
		Spread Spectrum Mode (SS)	9.5		mA (max)
$I_{SD}$	Shutdown Current	$V_{SD\_BOOST} = V_{SD\_AMP} = SS = FB\_SEL = GND$	0.01	1	$\mu A$
$V_{IH}$	Logic Voltage Input High		0.91		V (min)
$V_{IL}$	Logic Voltage Input Low		0.79		V
$T_{WU}$	Wake-up Time	$C_{SS} = 0.1\mu F$	49		ms
$V_{OS}$	Output Offset Voltage	Note 12	0.04		mV
$P_O$	Output Power	$R_L = 8\Omega, f = 1kHz, BW = 22kHz$			
		THD+N = 1%			
		FF	1	0.84	W (min)
		SS	1		W
		THD+N = 10%			
		FF	1.3		W
		SS	1.3		W
		$R_L = 4\Omega, f = 1kHz, BW = 22kHz$			
THD+N = 1%					
FF	1.8		W		
SS	1.8		W		
THD+N = 10%					
FF	2.2		W		
SS	2.2		W		
THD+N	Total Harmonic Distortion + Noise	$P_O = 500mW, f = 1kHz, R_L = 8\Omega$			
		FF	0.02		%
		SS	0.03		%
		$P_O = 500mW, f = 1kHz, R_L = 4\Omega$			
FF	0.04		%		
SS	0.06		%		
$\epsilon_{OS}$	Output Noise	$f = 20Hz$ to $20kHz$ Inputs to AC GND, No weighting			
		FF	35		$\mu V_{RMS}$
		SS	35		$\mu V_{RMS}$
		$f = 20Hz$ to $20kHz$ Inputs to AC GND, A weighted			
FF	25		$\mu V_{RMS}$		
SS	25		$\mu V_{RMS}$		



Symbol	Parameter	Conditions	LM48511		Units (Limits)
			Typical (Note 6)	Limit (Note 7)	
PSRR	Power Supply Rejection Ratio (Input Referred)	$V_{\text{RIPPLE}} = 200\text{mV}_{\text{P-P Sine}}$ , $f_{\text{RIPPLE}} = 217\text{Hz}$ FF SS	89 89		dB dB
		$V_{\text{RIPPLE}} = 200\text{mV}_{\text{P-P Sine}}$ , $f_{\text{RIPPLE}} = 1\text{kHz}$ FF SS	88 88		dB dB
		$V_{\text{RIPPLE}} = 200\text{mV}_{\text{P-P Sine}}$ , $f_{\text{RIPPLE}} = 10\text{kHz}$ FF SS	78 78		dB dB
CMRR	Common Mode Rejection Ratio (Input Referred)	$V_{\text{RIPPLE}} = 1\text{V}_{\text{P-P}}$ , $f_{\text{RIPPLE}} = 217\text{Hz}$	71		dB
$\eta$	Efficiency	$f = 1\text{kHz}$ , $R_L = 8\Omega$ , $P_O = 1\text{W}$	75		%
$V_{\text{FB}}$	Feedback Pin Reference Voltage		1.23		V

**Note 1:** "Absolute Maximum Ratings" indicate limits beyond which damage to the device may occur, including inoperability and degradation of device reliability and/or performance. Functional operation of the device and/or non-degradation at the *Absolute Maximum Ratings* or other conditions beyond those indicated in the *Recommended Operating Conditions* is not implied. The *Recommended Operating Conditions* indicate conditions at which the device is functional and the device should not be operated beyond such conditions. All voltages are measured with respect to the ground pin, unless otherwise specified.

**Note 2:** The *Electrical Characteristics* tables list guaranteed specifications under the listed *Recommended Operating Conditions* except as otherwise modified or specified by the *Electrical Characteristics Conditions* and/or Notes. Typical specifications are estimations only and are not guaranteed.

**Note 3:** The maximum power dissipation must be derated at elevated temperatures and is dictated by  $T_{\text{JMAX}}$ ,  $\theta_{\text{JA}}$ , and the ambient temperature,  $T_A$ . The maximum allowable power dissipation is  $P_{\text{DMAX}} = (T_{\text{JMAX}} - T_A) / \theta_{\text{JA}}$  or the number given in *Absolute Maximum Ratings*, whichever is lower. For the LM48511, see power derating curves for additional information.

**Note 4:** Human body model, applicable std. JESD22-A114C.

**Note 5:** Machine model, applicable std. JESD22-A115-A.

**Note 6:** Typical values represent most likely parametric norms at  $T_A = +25^\circ\text{C}$ , and at the *Recommended Operation Conditions* at the time of product characterization and are not guaranteed.

**Note 7:** Datasheet min/max specification limits are guaranteed by test or statistical analysis.

**Note 8:** Shutdown current is measured with components R1 and R2 removed.

**Note 9:** Feedback pin reference voltage is measured with the Audio Amplifier disconnected from the Boost converter (the Boost converter is unloaded).

**Note 10:**  $R_L$  is a resistive load in series with two inductors to simulate an actual speaker load for  $R_L = 8\Omega$ , the load is  $15\mu\text{H}+8\Omega+15\mu\text{H}$ . For  $R_L = 4\Omega$ , the load is  $15\mu\text{H}+4\Omega+15\mu\text{H}$ .

**Note 11:** Offset voltage is determined by:  $(I_{\text{DD (with load)}} - I_{\text{DD (no load)}}) \times R_L$ .

# Typical Performance Characteristics

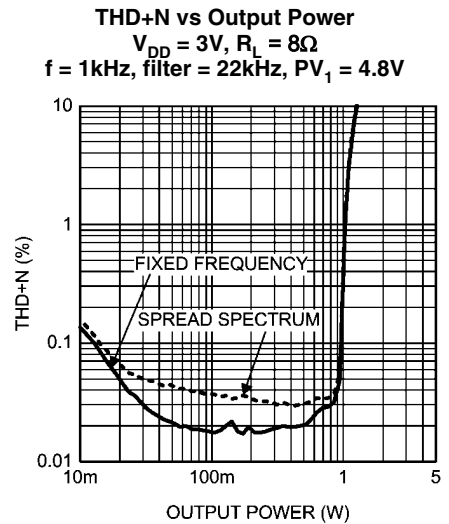
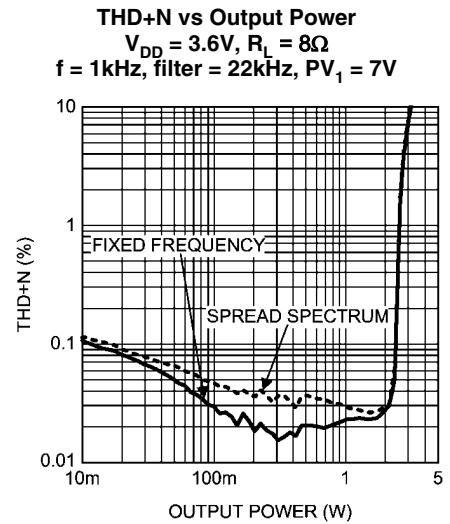
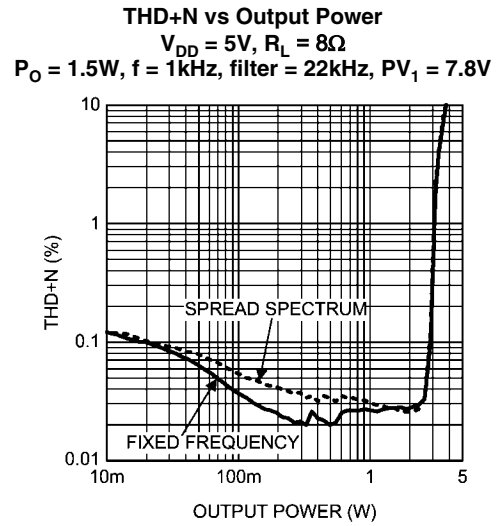
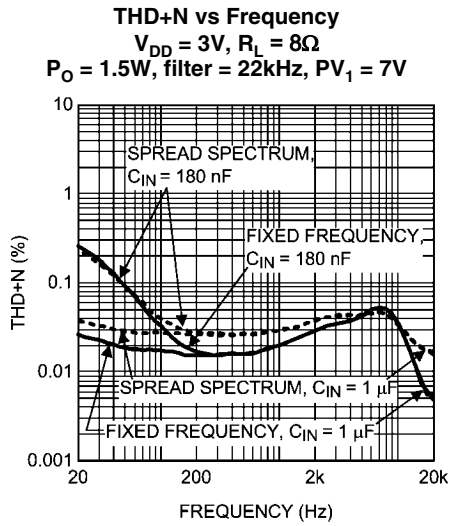
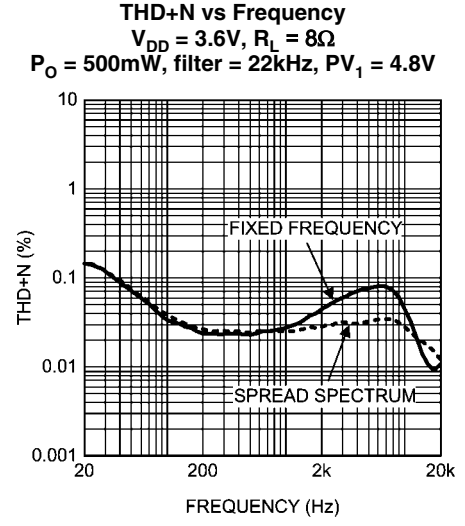
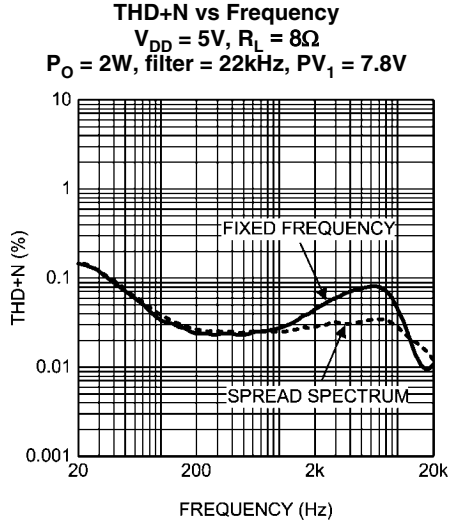

**THD+N vs Output Power**  
 $V_{DD} = 3V, 3.6V, 5V, R_L = 8\Omega$   
 $f = 1kHz, \text{filter} = 22kHz, R_1 = 4.87k\Omega, FF$

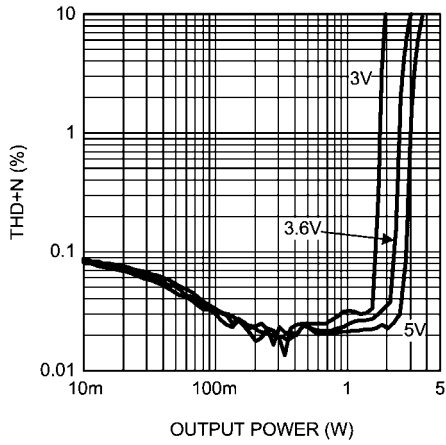

3002221

**THD+N vs Output Power**  
 $V_{DD} = 3.6V, R_L = 8\Omega$   
 $\text{filter} = 22kHz, PV_1 = 7.8V, PV_1 = 7V, PV_1 = 4.8V, FF$

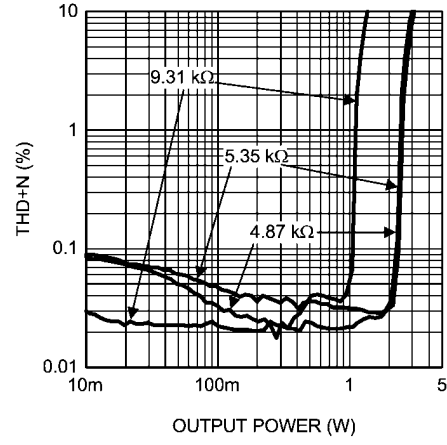

3002220

**Boost Amplifier vs Output Power**  
 $V_{DD} = 5V, R_L = 8\Omega$   
 $f = 1kHz, PV_1 = 7.8V$

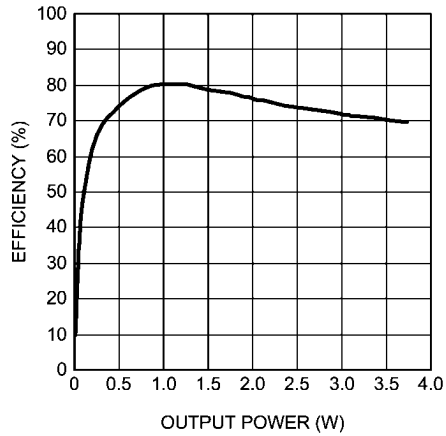

30022217

**Boost Amplifier vs Output Power**  
 $V_{DD} = 3.6V, R_L = 8\Omega$   
 $f = 1kHz, PV_1 = 7V$

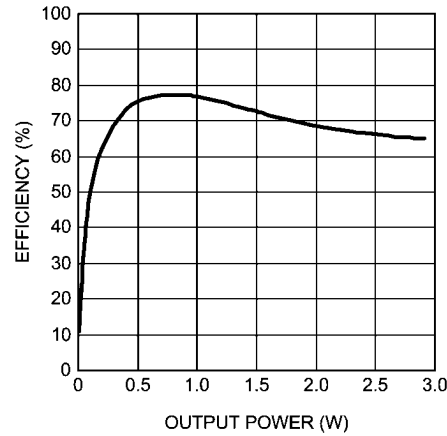

30022215

**Boost Amplifier vs Output Power**  
 $V_{DD} = 3V, R_L = 8\Omega$   
 $f = 1kHz, PV_1 = 4.8V$

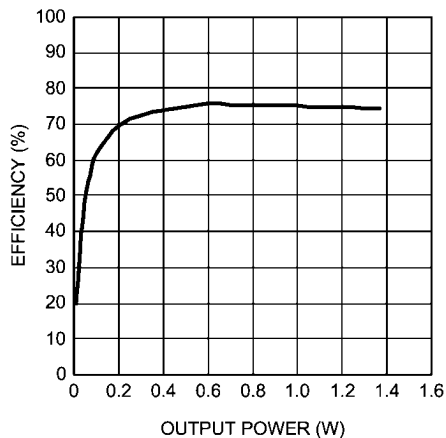

30022216

**PSRR vs Frequency**  
 $V_{DD} = 5V, R_L = 8\Omega$   
 $V_{RIPPLE} = 200mV_{pp}, PV_1 = 7.8V$

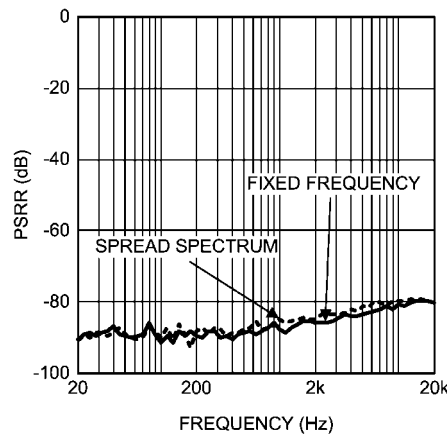

300222g3

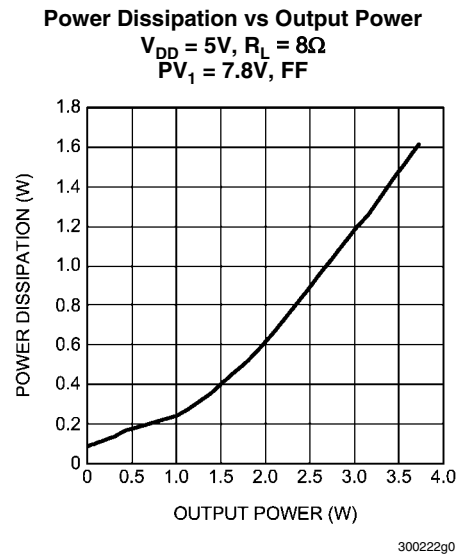
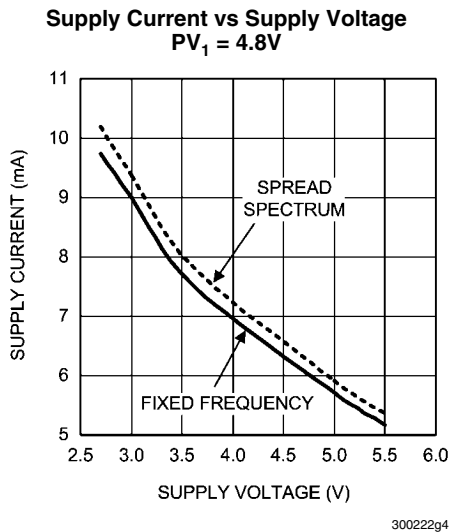
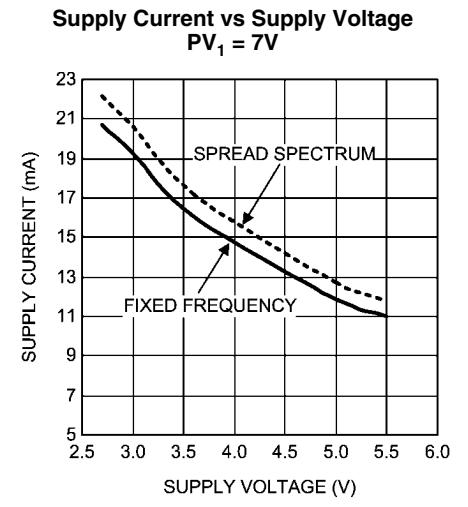
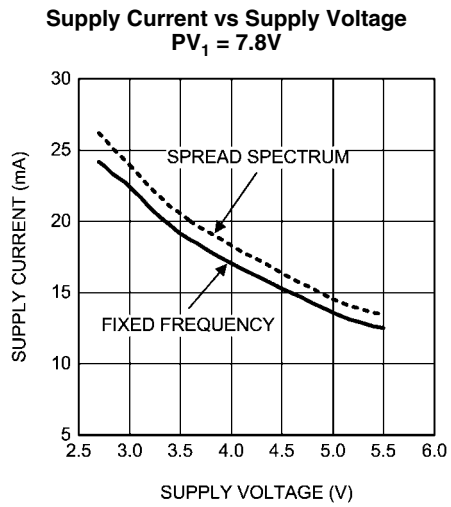
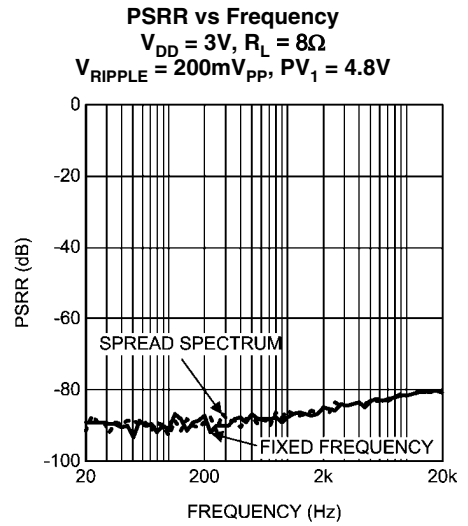
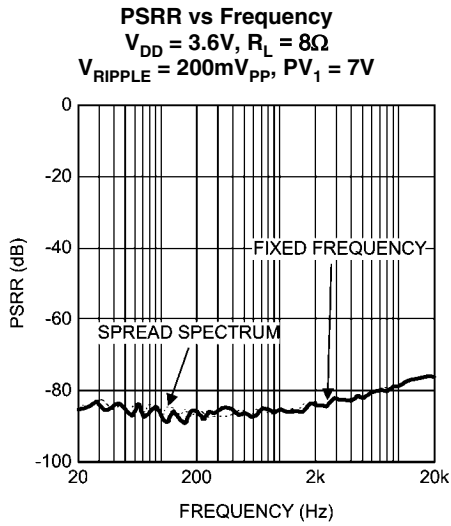

**Power Dissipation vs Output Power**

$V_{DD} = 3.6V, R_L = 8\Omega$   
 $PV_1 = 7V, FF$

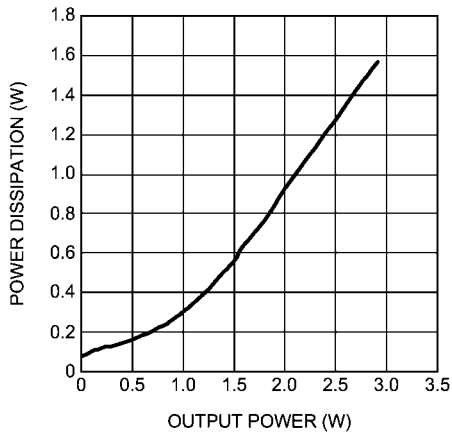

300222f8

**Power Dissipation vs Output Power**

$V_{DD} = 3V, R_L = 8\Omega$   
 $PV_1 = 4.8V, FF$

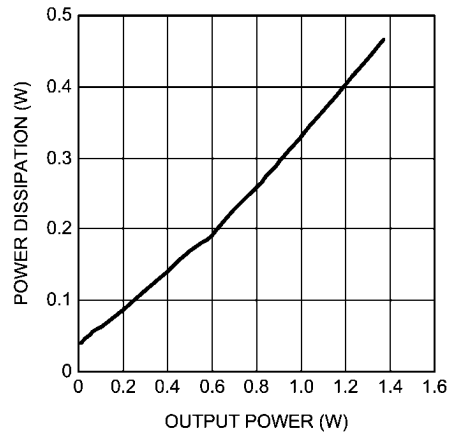

300222f9

**Boost Converter Efficiency vs I<sub>LOAD(DC)</sub>**

$V_{DD} = 5V, PV_1 = 7.8V$

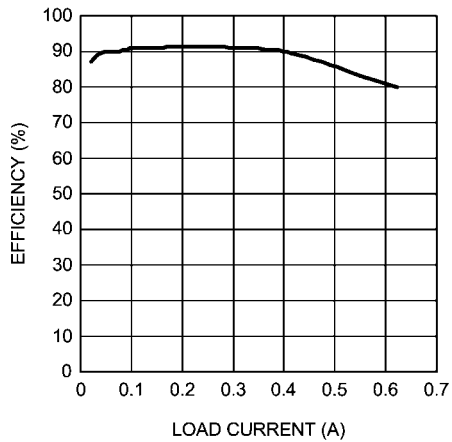

300222h8

**Boost Converter Efficiency vs I<sub>LOAD(DC)</sub>**

$V_{DD} = 3.6V, PV_1 = 7V$

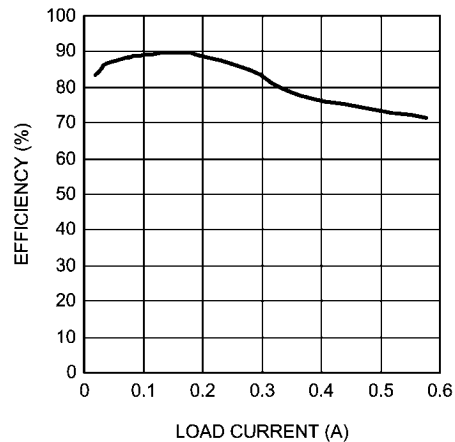

300222h6

**Boost Converter Efficiency vs I<sub>LOAD(DC)</sub>**

$V_{DD} = 3V, PV_1 = 4.8V$

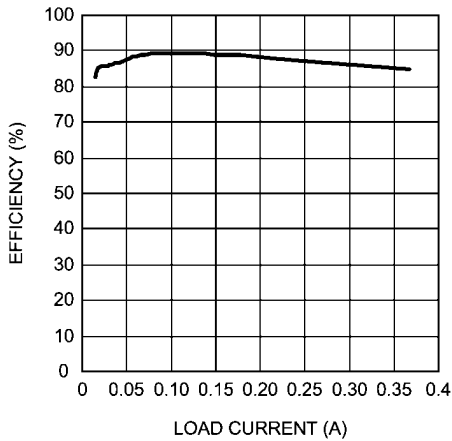

300222h7

## Application Information

### GENERAL AMPLIFIER FUNCTION

The LM48511 features a Class D audio power amplifier that utilizes a filterless modulation scheme, reducing external component count, conserving board space and reducing system cost. The outputs of the device transition from PV1 to GND with a 300kHz switching frequency. With no signal applied, the outputs ( $V_{LS+}$  and  $V_{LS-}$ ) switch with a 50% duty cycle, in phase, causing the two outputs to cancel. This cancellation results in no net voltage across the speaker, thus there is no current to the load in the idle state.

With the input signal applied, the duty cycle (pulse width) of the LM48511 outputs changes. For increasing output voltage, the duty cycle of  $V_{LS+}$  increases, while the duty cycle of  $V_{LS-}$  decreases. For decreasing output voltages, the converse occurs. The difference between the two pulse widths yields the differential output voltage.

### FIXED FREQUENCY

The LM48511 features two modulation schemes, a fixed frequency mode (FF) and a spread spectrum mode (SS). Select the fixed frequency mode by setting  $SS/\overline{FF} = \text{GND}$ . In fixed frequency mode, the amplifier outputs switch at a constant 300kHz. In fixed frequency mode, the output spectrum consists of the fundamental and its associated harmonics (see Typical Performance Characteristics).

### SPREAD SPECTRUM MODE

The logic selectable spread spectrum mode eliminates the need for output filters, ferrite beads or chokes. In spread spectrum mode, the switching frequency varies randomly by 10% about a 330kHz center frequency, reducing the wide-band spectral content, improving EMI emissions radiated by the speaker and associated cables and traces. Where a fixed frequency class D exhibits large amounts of spectral energy at multiples of the switching frequency, the spread spectrum architecture of the LM48511 spreads that energy over a larger bandwidth (See Typical Performance Characteristics). The cycle-to-cycle variation of the switching period does not affect the audio reproduction, efficiency, or PSRR. Set  $SS/\overline{FF} = V_{DD}$  for spread spectrum mode.

### DIFFERENTIAL AMPLIFIER EXPLANATION

The LM48511 includes fully differential amplifier that features differential input and output stages. A differential amplifier amplifies the difference between the two input signals. Traditional audio power amplifiers have typically offered only single-ended inputs resulting in a 6dB reduction in signal to noise ratio relative to differential inputs. The LM48511 also offers the possibility of DC input coupling which eliminates the two external AC coupling, DC blocking capacitors. The LM48511 can be used, however, as a single ended input amplifier while still retaining its fully differential benefits. In fact, completely unrelated signals may be placed on the input pins. The LM48511 simply amplifies the difference between the signals. A major benefit of a differential amplifier is the improved common mode rejection ratio (CMRR) over single input amplifiers. The common-mode rejection characteristic of the differential amplifier reduces sensitivity to ground offset related noise injection, especially important in high noise applications.

### AUDIO AMPLIFIER POWER DISSIPATION AND EFFICIENCY

The major benefit of a Class D amplifier is increased efficiency versus a Class AB. The efficiency of the LM48511 is attributed to the region of operation of the transistors in the output stage.

The Class D output stage acts as current steering switches, consuming negligible amounts of power compared to their Class AB counterparts. Most of the power loss associated with the output stage is due to the IR loss of the MOSFET on-resistance, along with switching losses due to gate charge.

### REGULATOR POWER DISSIPATION

At higher duty cycles, the increased ON-time of the switch FET means the maximum output current will be determined by power dissipation within the LM48511 FET switch. The switch power dissipation from ON-time conduction is calculated by:

$$P_{D(\text{SWITCH})} = DC \times (I_{\text{INDUCTOR(AVE)}})^2 \times R_{\text{DS(ON)}} \text{ (W)} \quad (1)$$

where DC is the duty cycle.

### SHUTDOWN FUNCTION

The LM48511 features independent amplifier and regulator shutdown controls, allowing each portion of the device to be disabled or enabled independently.  $\overline{SD\_AMP}$  controls the Class D amplifiers, while  $\overline{SD\_BOOST}$  controls the regulator. Driving either inputs low disables the corresponding portion of the device, and reducing supply current.

When the regulator is disabled, both  $\text{FB\_GND}$  switches open, further reducing shutdown current by eliminating the current path to GND through the regulator feedback network. Without the GND switches, the feedback resistors as shown in Figure 1 would consume an additional 165 $\mu\text{A}$  from a 5V supply. With the regulator disabled, there is still a current path from  $V_{DD}$ , through the inductor and diode, to the amplifier power supply. This allows the amplifier to operate even when the regulator is disabled. The voltage at PV1 and V1 will be:

$$(V_{DD} - [V_D + (I_L \times \text{DCR})]) \quad (2)$$

Where  $V_D$  is the forward voltage of the Schottky diode,  $I_L$  is the current through the inductor, and DCR is the DC resistance of the inductor. Additionally, when the regulator is disabled, an external voltage between 5V and 8V can be applied directly to PV1 and V1 to power the amplifier.

It is best to switch between ground and  $V_{DD}$  for minimum current consumption while in shutdown. The LM48511 may be disabled with shutdown voltages in between GND and  $V_{DD}$ , the idle current will be greater than the typical 0.1 $\mu\text{A}$  value. Increased THD+N may also be observed when a voltage of less than  $V_{DD}$  is applied to  $\overline{SD\_AMP}$ .

### REGULATOR FEEDBACK SELECT

The LM48511 regulator features two feedback paths as shown in Figure 1, which allow the regulator to easily switch between two different output voltages. The voltage divider consists of the high side resistor, R3, and the low side resistors ( $R_{LS}$ ), R1 and R2. R3 is connected to the output of the boost regulator, the mid-point of each divider is connected to FB, and the low side resistors are connected to either  $\text{FB\_GND1}$  or  $\text{FB\_GND0}$ .  $\text{FB\_SEL}$  determines which  $\text{FB\_GND}$  switch is closed, which in turn determines which feedback path is used. For example if  $\text{FB\_SEL} = V_{DD}$ , the  $\text{FB\_GND1}$  switch is closed, while the  $\text{FB\_GND0}$  switch remains open, creating a current path through the resistors connected to  $\text{FB\_GND1}$ . Conversely, if  $\text{FB\_SEL} = \text{GND}$ , the  $\text{FB\_GND0}$  switch is closed, while the  $\text{FB\_GND1}$  switch remains open, creating a current path through the resistors connected to  $\text{FB\_GND0}$ .

FB\_SEL can be susceptible to noise interference. To prevent an accidental state change, either bypass FB\_SEL with a 0.1µF capacitor to GND, or connect the higher voltage feedback network to FB\_GND0, and the lower voltage feedback network to FB\_GND1. Because the higher output voltage configuration typically generates more noise on V<sub>DD</sub>, this configuration minimizes the V<sub>DD</sub> noise exposure of FB\_SEL, as FB\_SEL = GND for FB\_GND0 (high voltage output) and FB\_SEL = V<sub>DD</sub> for FB\_GND1 (low voltage output).

The selectable feedback networks maximize efficiency in two ways. In applications where the system power supply voltage changes, such as a mobile GPS receiver, that transitions from battery power, to AC line, to a car power adapter, the LM48511 can be configured to generate a lower voltage when the system power supply voltages is lower, and conversely, generate a higher voltage when the system power supply is higher. See the Setting the Regulator Output Voltage (PV1) section.

In applications where the same speaker/amplifier combination is used for different purposes with different audio power requirements, such as a cell phone ear piece/speaker phone speaker, the ability to quickly switch between two different voltages allows for optimization of the amplifier power supply, increasing overall system efficiency. When audio power demands are low (ear piece mode) the regulator output voltage can be set lower, reducing quiescent current consumption. When audio power demands increase (speaker phone mode), a higher voltage increases the amplifier headroom, increasing the audio power delivered to the speaker.

#### PROPER SELECTION OF EXTERNAL COMPONENTS

Proper selection of external components in applications using integrated power amplifiers, and switching DC-DC converters, is critical for optimizing device and system performance. Consideration to component values must be used to maximize overall system quality. The best capacitors for use with the switching converter portion of the LM48511 are multi-layer ceramic capacitors. They have the lowest ESR (equivalent series resistance) and highest resonance frequency, which makes them optimum for high frequency switching converters. When selecting a ceramic capacitor, only X5R and X7R dielectric types should be used. Other types such as Z5U and Y5F have such severe loss of capacitance due to effects of temperature variation and applied voltage, they may provide as little as 20% of rated capacitance in many typical applications. Always consult capacitor manufacturer's data curves before selecting a capacitor. High-quality ceramic capacitors can be obtained from Taiyo-Yuden and Murata.

#### POWER SUPPLY BYPASSING

As with any amplifier, proper supply bypassing is critical for low noise performance and high power supply rejection. The capacitor location on both PV1, V1 and V<sub>DD</sub> pins should be as close to the device as possible.

#### AUDIO AMPLIFIER GAIN SETTING RESISTOR SELECTION

The amplifier gain of the LM48511 is set by four external resistors, the input resistors, R5 and R7, and the feedback resistors R6 and R8. The amplifier gain is given by:

Where R<sub>IN</sub> is the input resistor and R<sub>F</sub> is the feedback resistor.

$$A_{VD} = 2 \times R_F / R_{IN} \quad (3)$$

Careful matching of the resistor pairs, R6 and R8, and R5 and R7, is required for optimum performance. Any mismatch be-

tween the resistors results in a differential gain error that leads to an increase in THD+N, decrease in PSRR and CMRR, as well as an increase in output offset voltage. Resistors with a tolerance of 1% or better are recommended.

The gain setting resistors should be placed as close to the device as possible. Keeping the input traces close together and of the same length increases noise rejection in noisy environments. Noise coupled onto the input traces which are physically close to each other will be common mode and easily rejected.

#### AUDIO AMPLIFIER INPUT CAPACITOR SELECTION

Input capacitors may be required for some applications, or when the audio source is single-ended. Input capacitors block the DC component of the audio signal, eliminating any conflict between the DC component of the audio source and the bias voltage of the LM48511. The input capacitors create a high-pass filter with the input resistors R<sub>IN</sub>. The -3dB point of the high pass filter is found by:

$$f = 1 / 2\pi R_{IN} C_{IN} \quad (4)$$

In single-ended configurations, the input capacitor value affects click-and-pop performance. The LM48511 features a 50ms turn-on delay. Choose the input capacitor / input resistor values such that the capacitor is charged before the 50ms turn-on delay expires. A capacitor value of 0.18µF and a 20kΩ input resistor are recommended. In differential applications, the charging of the input capacitor does not affect click-and-pop significantly.

The input capacitors can also be used to remove low frequency content from the audio signal. High pass filtering the audio signal helps protect speakers that can not reproduce or may be damaged by low frequencies. When the LM48511 is using a single-ended source, power supply noise on the ground is seen as an input signal. Setting the high-pass filter point above the power supply noise frequencies, 217Hz in a GSM phone, for example, filters out the noise such that it is not amplified and heard on the output. Capacitors with a tolerance of 10% or better are recommended for impedance matching and improved CMRR and PSRR.

#### SELECTING REGULATOR OUTPUT CAPACITOR

A single 100µF low ESR tantalum capacitor provides sufficient output capacitance for most applications. Higher capacitor values improve line regulation and transient response. Typical electrolytic capacitors are not suitable for switching converters that operate above 500kHz because of significant ringing and temperature rise due to self-heating from ripple current. An output capacitor with excessive ESR reduces phase margin and causes instability.

#### SELECTING REGULATING BYPASS CAPACITOR

A supply bypass capacitor is required to serve as an energy reservoir for the current which must flow into the coil each time the switch turns on. This capacitor must have extremely low ESR, so ceramic capacitors are the best choice. A nominal value of 10µF is recommended, but larger values can be used. Since this capacitor reduces the amount of voltage ripple seen at the input pin, it also reduces the amount of EMI passed back along that line to other circuitry.

#### SELECTING THE SOFTSTART (C<sub>SS</sub>) CAPACITOR

The soft-start function charges the boost converter reference voltage slowly. This allows the output of the boost converter to ramp up slowly thus limiting the transient current at startup.

Selecting a soft-start capacitor ( $C_{SS}$ ) value presents a trade off between the wake-up time and the startup transient current. Using a larger capacitor value will increase wake-up time and decrease startup transient current while the opposite effect happens with a smaller capacitor value. A general guideline is to use a capacitor value 1000 times smaller than the output capacitance of the boost converter ( $C_2$ ). A 0.1 $\mu$ F soft-start capacitor is recommended for a typical application.

The following table shows the relationship between  $C_{SS}$  start-up time and surge current.

$C_{SS}$ ( $\mu$ F)	Boost Set-up Time (ms)	Input Surge Current (mA)
0.1	5.1	330
0.22	10.5	255
0.47	21.7	220

$V_{DD} = 5V$ ,  $PV_1 = 7.8V$  (continuous mode)

### SELECTING DIODE (D1)

Use a Schottky diode, as shown in Figure 1. A 30V diode such as the DFSL230LH from Diodes Incorporated is recommended. The DFSL230LH diodes are designed to handle a maximum average current of 2A.

### DUTY CYCLE

The maximum duty cycle of the boost converter determines the maximum boost ratio of output-to-input voltage that the converter can attain in continuous mode of operation. The duty cycle for a given boost application is defined by:

$$\text{Duty Cycle} = (PV_1 + V_D - V_{DD}) / (PV_1 + V_D - V_{SW}) \quad (5)$$

This applies for continuous mode operation.

### SELECTING INDUCTOR VALUE

Inductor value involves trade-offs in performance. Larger inductors reduce inductor ripple current, which typically means less output voltage ripple (for a given size of output capacitor). Larger inductors also mean more load power can be delivered because the energy stored during each switching cycle is:

$$E = L/2 \times I_p^2 \quad (6)$$

Where “ $I_p$ ” is the peak inductor current. The LM48511 will limit its switch current based on peak current. With  $I_p$  fixed, increasing L will increase the maximum amount of power available to the load. Conversely, using too little inductance may limit the amount of load current which can be drawn from the output. Best performance is usually obtained when the converter is operated in “continuous” mode at the load current range of interest, typically giving better load regulation and less output ripple. Continuous operation is defined as not allowing the inductor current to drop to zero during the cycle. Boost converters shift over to discontinuous operation if the load is reduced far enough, but a larger inductor stays continuous over a wider load current range.

### INDUCTOR SUPPLIES

The recommended inductor for the LM48511 is the IHLP-2525CZ-01 from Vishay Dale. When selecting an inductor, the continuous current rating must be high enough to avoid saturation at peak currents. A suitable core type must be used to minimize switching losses, and DCR losses must

be considered when selecting the current rating. Use shielded inductors in systems that are susceptible to RF interference.

### SETTING THE REGULATOR OUTPUT VOLTAGE (PV1)

The output voltage of the regulator is set through one of two external resistive voltage-dividers ( $R_3$  in combination with either  $R_1$  or  $R_2$ ) connected to FB (Figure 1). The resistor,  $R_4$  is only for compensation purposes and does not affect the regulator output voltage. The regulator output voltage is set by the following equation:

$$PV_1 = V_{FB} [1 + R_3/R_{LS}] \quad (7)$$

Where  $V_{FB}$  is 1.23V, and  $R_{LS}$  is the low side resistor ( $R_1$  or  $R_2$ ). To simplify resistor selection:

$$R_{LS} = (R_3 V_{FB}) / (PV_1 - V_{FB}) \quad (8)$$

A value of approximately 25.5k $\Omega$  is recommended for  $R_3$ .

The quiescent current of the boost regulator is directly related to the difference between its input and output voltages, the larger the difference, the higher the quiescent current. For improved power consumption the following regulator input/output voltage combinations are recommended:

$V_{DD}$ (V)	PV1 (V)	$R_3$ (k $\Omega$ )	$R_{LS}$ (k $\Omega$ )	$P_{OUT}$ into 8 $\Omega$ (W)
3.0	4.8	25.5	9.31	1
3.6	7.1	25.5	5.35	2.5
5	7.8	25.5	4.87	3

The values of PV1 are for continuous mode operation.

For feedback path selection, see Regulator Feedback Select section.

### DISCONTINUOUS/CONTINUOUS OPERATION

The LM48511 regulator features two different switching modes. Under light load conditions, the regulator operates in a variable frequency, discontinuous, pulse skipping mode, that improves light load efficiency by minimizing losses due to MOSFET gate charge. Under heavy loads, the LM48511 regulator automatically switches to a continuous, fixed frequency PWM mode, improving load regulation. In discontinuous mode, the regulator output voltage is typically 400mV higher than the expected (calculated) voltage in continuous mode.

### $I_{SW}$ FEED-FORWARD COMPENSATION FOR BOOST CONVERTER

Although the LM48511 regulator is internally compensated, an external feed-forward capacitor, ( $C_1$ ) may be required for stability (Figure 1). The compensation capacitor places a zero in regulator loop response. The recommended frequency of the zero ( $f_z$ ) is 22.2kHz. The value of  $C_1$  is given by:

$$C_1 = 1 / 2\pi R_3 f_z \quad (9)$$

In addition to  $C_1$ , a compensation resistor,  $R_4$  is required to cancel the zero contributed by the ESR of the regulator output capacitor. Calculate the zero frequency of the output capacitor by:

$$f_{CO} = 1 / 2\pi R_{CO} C_O \quad (10)$$



Where  $R_{CO}$  is the ESR of the output capacitor. The value of  $R_{FB3}$  is given by:

$$R4 = 1 / 2\pi f_{CO} C1 \quad (11)$$

#### CALCULATING REGULATOR OUTPUT CURRENT

The load current of the boost converter is related to the average inductor current by the relation:

$$I_{AMP} = I_{INDUCTOR(AVE)} \times (1 - DC) \quad (A) \quad (12)$$

Where "DC" is the duty cycle of the application.

The switch current can be found by:

$$I_{SW} = I_{INDUCTOR(AVE)} + 1/2 (I_{RIPPLE}) \quad (A) \quad (13)$$

Inductor ripple current is dependent on inductance, duty cycle, supply voltage and frequency:

$$I_{RIPPLE} = DC \times (V_{DD} - V_{SW}) / (f \times L) \quad (A) \quad (14)$$

where  $f$  = switching frequency = 1MHz

combining all terms, we can develop an expression which allows the maximum available load current to be calculated:

$$I_{AMP(max)} = (1 - DC) \times [I_{SW(max)} - DC(V - V_{SW})] / 2fL \quad (A) \quad (15)$$

The equation shown to calculate maximum load current takes into account the losses in the inductor or turn-off switching losses of the FET and diode.

#### DESIGN PARAMETERS $V_{SW}$ AND $I_{SW}$

The value of the FET "ON" voltage (referred to as  $V_{SW}$  in equations 9 thru 12) is dependent on load current. A good approximation can be obtained by multiplying the on resistance ( $R_{DS(ON)}$ ) of the FET times the average inductor current. The maximum peak switch current the device can deliver is dependent on duty cycle.

## Build Of Materials

Designator	Description	Footprint	Quantity	Value
Cf1	CHIP CAPACITOR GENERIC	CAP 0805	1	470pF
CINA	CHIP CAPACITOR GENERIC	CAP 1210	1	1 $\mu$ F
CINB	CHIP CAPACITOR GENERIC	CAP 1210	1	1 $\mu$ F
Co	CHIP CAPACITOR GENERIC	CAP 1210	1	10 $\mu$ F
Cs1	CHIP CAPACITOR GENERIC	CAP 1210	1	2.2 $\mu$ F
Cs2	CHIP CAPACITOR GENERIC	CAP 1210	1	4.7 $\mu$ F
D1	SCHOTTKY DIO	DIODE MBR0520 IR	1	
L1		IND_COILCRAFT-DO1813P	1	4.7 $\mu$ H
R1	CHIP RESISTOR GENERIC	RES 0805	1	41.2K
R2	CHIP RESISTOR GENERIC	RES 0805	1	13.3K
RINA	CHIP RESISTOR GENERIC	RES 0805	1	150K
RINB	CHIP RESISTOR GENERIC	RES 0805	1	150K

## Revision History

Rev	Date	Description
1.0	07/24/07	Initial release.
1.1	07/25/07	Input some text edits.
1.2	09/25/07	Changed the Amplifier Voltage (Operating Ratings section) from 5.0V to 4.8V.
1.3	11/06/07	Added another Po (@Vdd = 5V, RI = 4Ω) section in the Key Specification division.
1.4	02/25/08	Edited the Notes section.

**Physical Dimensions** inches (millimeters) unless otherwise noted

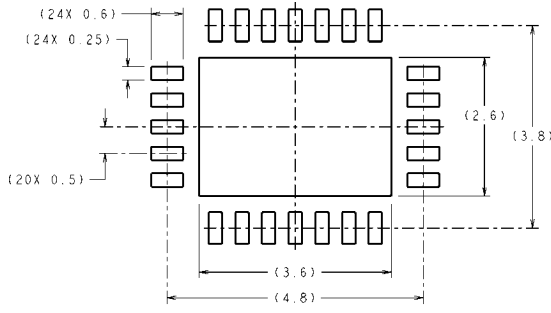

**RECOMMENDED LAND PATTERN**

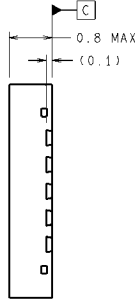
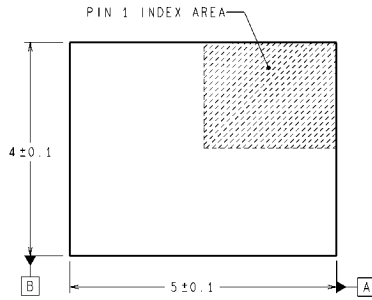

**DIMENSIONS ARE IN MILLIMETERS**  
DIMENSIONS IN ( ) FOR REFERENCE ONLY

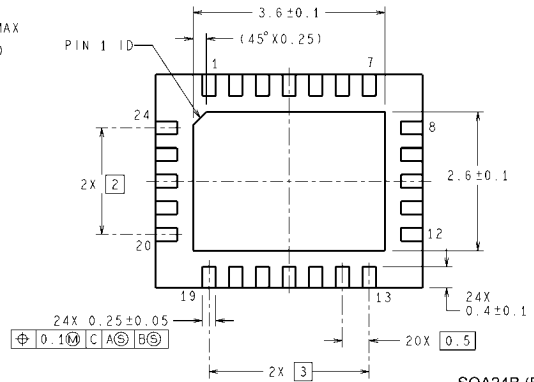

SQA24B (Rev A)

**SQ Package**  
**Order Number LM48511SQ**  
**NS Package Number SQA24B**

# Notes

LM48511

## Notes

For more National Semiconductor product information and proven design tools, visit the following Web sites at:

Products		Design Support	
Amplifiers	<a href="http://www.national.com/amplifiers">www.national.com/amplifiers</a>	WEBENCH	<a href="http://www.national.com/webench">www.national.com/webench</a>
Audio	<a href="http://www.national.com/audio">www.national.com/audio</a>	Analog University	<a href="http://www.national.com/AU">www.national.com/AU</a>
Clock Conditioners	<a href="http://www.national.com/timing">www.national.com/timing</a>	App Notes	<a href="http://www.national.com/appnotes">www.national.com/appnotes</a>
Data Converters	<a href="http://www.national.com/adc">www.national.com/adc</a>	Distributors	<a href="http://www.national.com/contacts">www.national.com/contacts</a>
Displays	<a href="http://www.national.com/displays">www.national.com/displays</a>	Green Compliance	<a href="http://www.national.com/quality/green">www.national.com/quality/green</a>
Ethernet	<a href="http://www.national.com/ethernet">www.national.com/ethernet</a>	Packaging	<a href="http://www.national.com/packaging">www.national.com/packaging</a>
Interface	<a href="http://www.national.com/interface">www.national.com/interface</a>	Quality and Reliability	<a href="http://www.national.com/quality">www.national.com/quality</a>
LVDS	<a href="http://www.national.com/lvds">www.national.com/lvds</a>	Reference Designs	<a href="http://www.national.com/refdesigns">www.national.com/refdesigns</a>
Power Management	<a href="http://www.national.com/power">www.national.com/power</a>	Feedback	<a href="http://www.national.com/feedback">www.national.com/feedback</a>
Switching Regulators	<a href="http://www.national.com/switchers">www.national.com/switchers</a>		
LDOs	<a href="http://www.national.com/ldo">www.national.com/ldo</a>		
LED Lighting	<a href="http://www.national.com/led">www.national.com/led</a>		
PowerWise	<a href="http://www.national.com/powerwise">www.national.com/powerwise</a>		
Serial Digital Interface (SDI)	<a href="http://www.national.com/sdi">www.national.com/sdi</a>		
Temperature Sensors	<a href="http://www.national.com/tempsensors">www.national.com/tempsensors</a>		
Wireless (PLL/VCO)	<a href="http://www.national.com/wireless">www.national.com/wireless</a>		

THE CONTENTS OF THIS DOCUMENT ARE PROVIDED IN CONNECTION WITH NATIONAL SEMICONDUCTOR CORPORATION ("NATIONAL") PRODUCTS. NATIONAL MAKES NO REPRESENTATIONS OR WARRANTIES WITH RESPECT TO THE ACCURACY OR COMPLETENESS OF THE CONTENTS OF THIS PUBLICATION AND RESERVES THE RIGHT TO MAKE CHANGES TO SPECIFICATIONS AND PRODUCT DESCRIPTIONS AT ANY TIME WITHOUT NOTICE. NO LICENSE, WHETHER EXPRESS, IMPLIED, ARISING BY ESTOPPEL OR OTHERWISE, TO ANY INTELLECTUAL PROPERTY RIGHTS IS GRANTED BY THIS DOCUMENT.

TESTING AND OTHER QUALITY CONTROLS ARE USED TO THE EXTENT NATIONAL DEEMS NECESSARY TO SUPPORT NATIONAL'S PRODUCT WARRANTY. EXCEPT WHERE MANDATED BY GOVERNMENT REQUIREMENTS, TESTING OF ALL PARAMETERS OF EACH PRODUCT IS NOT NECESSARILY PERFORMED. NATIONAL ASSUMES NO LIABILITY FOR APPLICATIONS ASSISTANCE OR BUYER PRODUCT DESIGN. BUYERS ARE RESPONSIBLE FOR THEIR PRODUCTS AND APPLICATIONS USING NATIONAL COMPONENTS. PRIOR TO USING OR DISTRIBUTING ANY PRODUCTS THAT INCLUDE NATIONAL COMPONENTS, BUYERS SHOULD PROVIDE ADEQUATE DESIGN, TESTING AND OPERATING SAFEGUARDS.

EXCEPT AS PROVIDED IN NATIONAL'S TERMS AND CONDITIONS OF SALE FOR SUCH PRODUCTS, NATIONAL ASSUMES NO LIABILITY WHATSOEVER, AND NATIONAL DISCLAIMS ANY EXPRESS OR IMPLIED WARRANTY RELATING TO THE SALE AND/OR USE OF NATIONAL PRODUCTS INCLUDING LIABILITY OR WARRANTIES RELATING TO FITNESS FOR A PARTICULAR PURPOSE, MERCHANTABILITY, OR INFRINGEMENT OF ANY PATENT, COPYRIGHT OR OTHER INTELLECTUAL PROPERTY RIGHT.

### LIFE SUPPORT POLICY

**NATIONAL'S PRODUCTS ARE NOT AUTHORIZED FOR USE AS CRITICAL COMPONENTS IN LIFE SUPPORT DEVICES OR SYSTEMS WITHOUT THE EXPRESS PRIOR WRITTEN APPROVAL OF THE CHIEF EXECUTIVE OFFICER AND GENERAL COUNSEL OF NATIONAL SEMICONDUCTOR CORPORATION.** As used herein:

Life support devices or systems are devices which (a) are intended for surgical implant into the body, or (b) support or sustain life and whose failure to perform when properly used in accordance with instructions for use provided in the labeling can be reasonably expected to result in a significant injury to the user. A critical component is any component in a life support device or system whose failure to perform can be reasonably expected to cause the failure of the life support device or system or to affect its safety or effectiveness.

National Semiconductor and the National Semiconductor logo are registered trademarks of National Semiconductor Corporation. All other brand or product names may be trademarks or registered trademarks of their respective holders.

Copyright© 2008 National Semiconductor Corporation

For the most current product information visit us at [www.national.com](http://www.national.com)



**National Semiconductor  
Americas Technical  
Support Center**  
Email:  
[new.feedback@nsc.com](mailto:new.feedback@nsc.com)  
Tel: 1-800-272-9959

**National Semiconductor Europe  
Technical Support Center**  
Email: [europe.support@nsc.com](mailto:europe.support@nsc.com)  
German Tel: +49 (0) 180 5010 771  
English Tel: +44 (0) 870 850 4288

**National Semiconductor Asia  
Pacific Technical Support Center**  
Email: [ap.support@nsc.com](mailto:ap.support@nsc.com)

**National Semiconductor Japan  
Technical Support Center**  
Email: [jpn.feedback@nsc.com](mailto:jpn.feedback@nsc.com)